

SAUDI TELECOM COMPANY

Reference Interconnection Offer (RIO)

Annex C

Technical Information

Version number:	Draft 2.0
Version date:	16 th February 2006
Date of original Issue:	23 rd April 2005
Authority for issue:	GM, Regulatory Affairs
Next scheduled review date:	1 st May 2007

DOCUMENT HISTORY & VERSION CONTROL RECORD

Name of document	Technical Information
Author	Director, Carrier Services
Authorised Officer	GM, Regulatory Affairs
Description of document	Contains all the Technical Information related to the Interconnection Service provided by STC.
Approved by	To be approved CITC
Date of approval	To be approved by CITC.
Assigned review period	Annual
Date of next review	01/05/2007

Version Number	Version Date	Authorised Officer	Amendment Details
1.0	23/04/2005	GM, Regulatory Affairs	Original issue of STC Reference Interconnection Offer – Technical Information.
Drfat 2.0	16/01/2006	GM, Regulatory Affairs	<ul style="list-style-type: none"> - Inclusion of Mobile to Mobile Interconnection - Inclusion of Interconnection at IGW Level - Change in Clause 5.6, bullet 2 - Addition of Clause 2.5 Calling Party categories and Clause 2.6 Cause Identifiers in Attachment 3 – Signalling Standards. - Inclusion of SMS definition as Clause 5.8 in Annex C - Changes made to clause 6.1, clause 7.4 and changes in fig .5 and fig. 8 and 3.1, Attachment 3 , to make the document more generic.

TABLE OF CONTENTS

Clause	Page number
1 STC Fixed Core Telephone Network	5
2 Exchanges	5
3 Point of Interconnection (POI).....	6
4 Switching Network Interconnection	7
5 Interconnection Links and Routing.....	8
6 Transport Network Topology	13
7 Signalling Network	14
8 SynchroniSation.....	16
9 Interface Standards.....	16
10 Numbering.....	18
11 Environmental and Power Requirements for Collocation.....	19

ATTACHMENTS

- Attachment 1: Distribution Frame Characteristics DDF and ODF
- Attachment 2: Points of Interconnection & Signalling Point Codes (POIs & SPCs)
- Attachment 3: Saudi Arabia SS7 Signalling Standard (SA-ISUP & MTP)
- Attachment 4: NXX Number Ranges of STC Exchanges
- Attachment 5: STC Synchronisation Scheme
- Attachment 6: Environmental & Power Requirements for Collocation

1 STC FIXED CORE TELEPHONE NETWORK

- 1.1 The current STC fixed telephone core network is illustrated in Figure 1 below. This includes a two-level architecture of Service Nodes (SNs) and Local Exchanges (LEs), in addition to 3 International Gateways (IGWs) at Riyadh, Jeddah and Dammam. The fixed core network has 28 Service Nodes, which are geographically distributed over the different regions and are extensively interconnected by the long distance transport of the core fixed network. STC will initially offer interconnection at the SN level only.

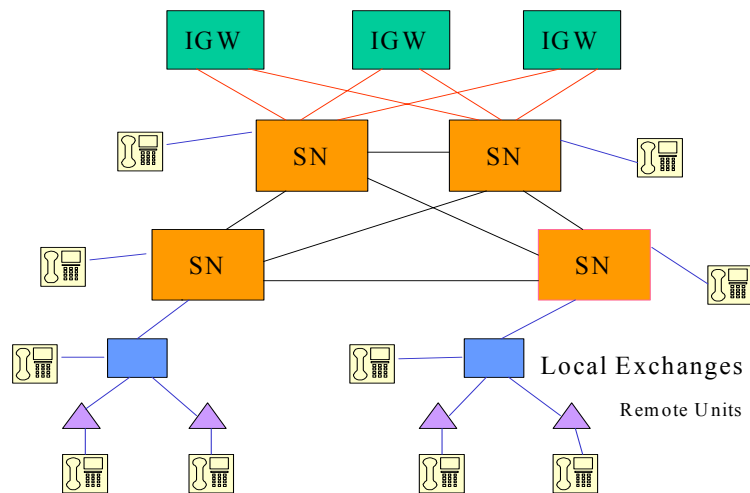

Figure 1: Overview of STC Fixed Telephone Network

2 EXCHANGES

- 2.1 The Local Exchange (LE) is the basic building block for customer access to STC's Public Switched Telephone Network (PSTN). Local Exchanges provide customer connectivity via the access network. Most Local Exchanges also parent Remote Units (or Remote Switching Units), which extend the geographic area over which customers are served. Service Nodes are the major switching elements in the network and they provide national transit capability, in addition to providing customer connectivity via the access network.

3 POINT OF INTERCONNECTION (POI)

- 3.1 STC will physically interconnect its Network with that of the Other Licensed Operator (OLO) at designated Points of Interconnection (POIs) associated with a number of nominated SNs. The POI is defined as the point between the STC Digital Distribution Frame (DDF), and possibly Optical Distribution Frame (ODF), connected to the nominated SN and the DDF/ODF of the Other Licensed Operator's designated Interconnection Node, as illustrated in Figure 2 and Figure 3 below.
- 3.2 The technical characteristics of the connection at the DDF/ODF will fulfil the requirements provided in Attachment 1 (*Characteristics of DDF and ODF*).
- 3.3 There are two modes of Interconnection, namely: Customer Sited Interconnection (CSI) as shown in Figure 2; and Collocated Interconnection as shown in Figure 3.
- 3.4 In the CSI mode, STC DDF and transmission terminal equipment will be installed at the boundary of or within the OLO site, to where STC technicians should be granted access. Both parties shall come to an agreement on adequate access arrangements that will allow STC to fulfill its respective obligations. Should it not be possible to arrive at an agreement, such obligation will become null and void until such time as the access arrangements are agreed.

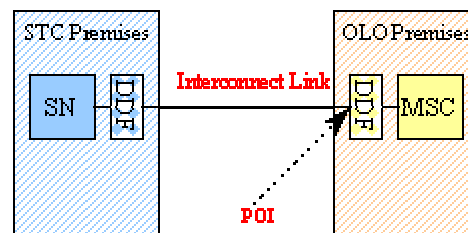

Figure 2: Customer Sited Interconnection

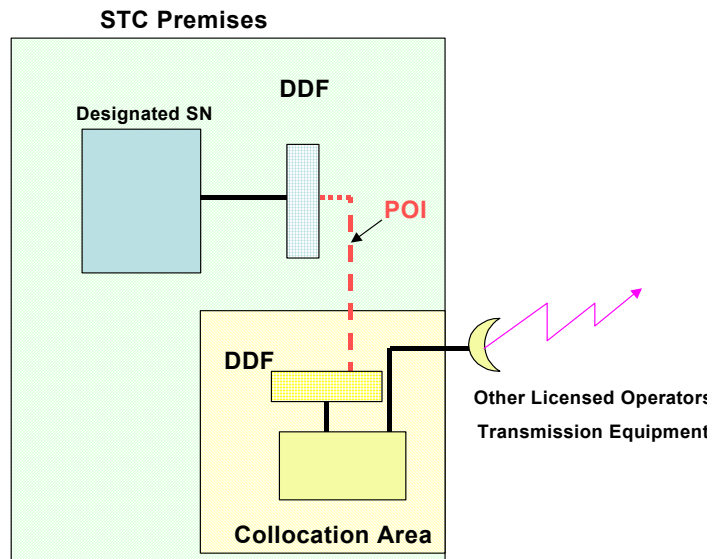

Figure 3: Collocated Interconnection

4 SWITCHING NETWORK INTERCONNECTION

4.1 The list of SNs/POIs, as at the date of this document, is presented in Attachment 2 (*Points of Interconnection & Signalling Point Codes*). This list will be updated periodically. Additional POIs will be determined by agreement between STC and the Other Licensed Operator as part of the Network Plan and will be consistent with Clause 4.2 below.

4.2 For interconnect between STC Networks and the Other Licensed Operator Network :

- a) Establish interconnection with STC at Points of Interconnection offered by STC, at the Service Node or at any other point of Interconnection which is technically and economically feasible .
- b) For Interconnect with a Kingdom wide OLO Public Network, the initial requirement is to establish interconnection at a minimum of two (2) Points of Interconnection in each of the 3 large Regions (Riyadh, Makkah, and Dammam) to ensure diversity and resilience. (The details of the initial

interconnection arrangement will be agreed during the initial network planning process.)

5 INTERCONNECTION LINKS AND ROUTING

- 5.1 Interconnection Links will be used as necessary to provide interconnection routes for the conveyance of the Other Licensed Operator's traffic into the STC network. Routes will be established in accordance with the Other Licensed Operator's agreed Network Plan and capacity forecasts as stipulated in Annex E (*Forecasting*).
- 5.2 Until routes are mature and traffic volumes become stable, interconnect routes will be uni-directional. At a later stage, bi-directional operation of these routes will be considered.
- 5.3 Route segregation will be based on traffic type (e.g. calls to geographic-national number ranges, mobile number ranges, international, etc.) and economic considerations. This will be agreed between the parties.
- 5.4 The Other Licensed Operator will be responsible for those routes on which it sends traffic to STC and will dimension the routes to meet the target Quality of Service measures stated in Annex I (*Quality of Service Measures*).
- 5.5 Interconnected voice calls to STC geographic number ranges will employ far end hand-over principles. This means that calls to geographic number ranges will only be permitted through the POI's that are nearest to those ranges. Depending on the selected set of POI's, a table will be established as part of the network plan described in Annex H (*Operations and Maintenance Manual*) that will associate each Number Range (NXX) with the permitted POIs (see Figure 4).
- 5.6 The main traffic routing categories, corresponding to the basic services, are illustrated in the diagrams below as follows:

- Voice calls terminating on STC geographic number ranges – Figure 4. Such calls will be routed within the OLO network and handed over to STC at the POI nearest to the called destination number ranges).
- Voice calls terminating on STC mobile number ranges – Figure 5.a shows the connection via the Service Node and Figure 5.b shows the direct connection to GMSC. Such calls will be routed from the OLO's network to the nearby STC POI as listed in Annex C Attachment 2..
- OLO's voice calls offered for International conveyance – Figure 6The Interconnection to the International Gateway via the Service Node is shown fig 6.a whereas fig6.b shows the direct Interconnection with the International Gateway.

- 5.7 The Other Licensed Operator shall be responsible for the number translation of short code dialled digits. These calls will be presented to the STC network using the appropriate translated geographic destination number based on the specific location of the calling party on a call-by-call basis. STC will provide the appropriate lookup tables within the agreed Network Plan as per Annex H (*Operations and Maintenance Manual*).
- 5.8 STC provides the Short Messaging Service (SMS) Interconnection Service to the Other Licensed Mobile Operator This Service involves the sending of Messages to the Mobile Phones or other devices belonging to the customers of STC and originated from the Mobile phones or other devices belonging to the customers of the Other Licensed Mobile Operator. The SMS Interconnection Service is carried over the signaling links provisioned by the OLO and STC based on the mutually agreed forecasts. The Short Messaging Service is a Messaging Service which uses the CCITT No.7 MAP Protocol and generally conforms to the GSM Technical Specifications of the GSM 03.40, GSM 04.11 and GSM 09.02(as amended from time to time).

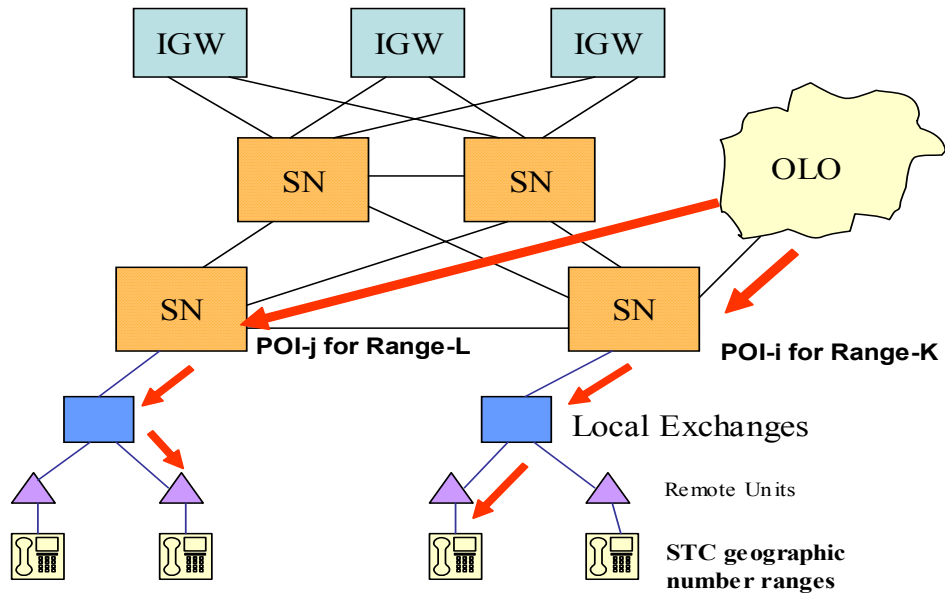

Figure 4: Voice Call Termination on STC Geographic Number Ranges

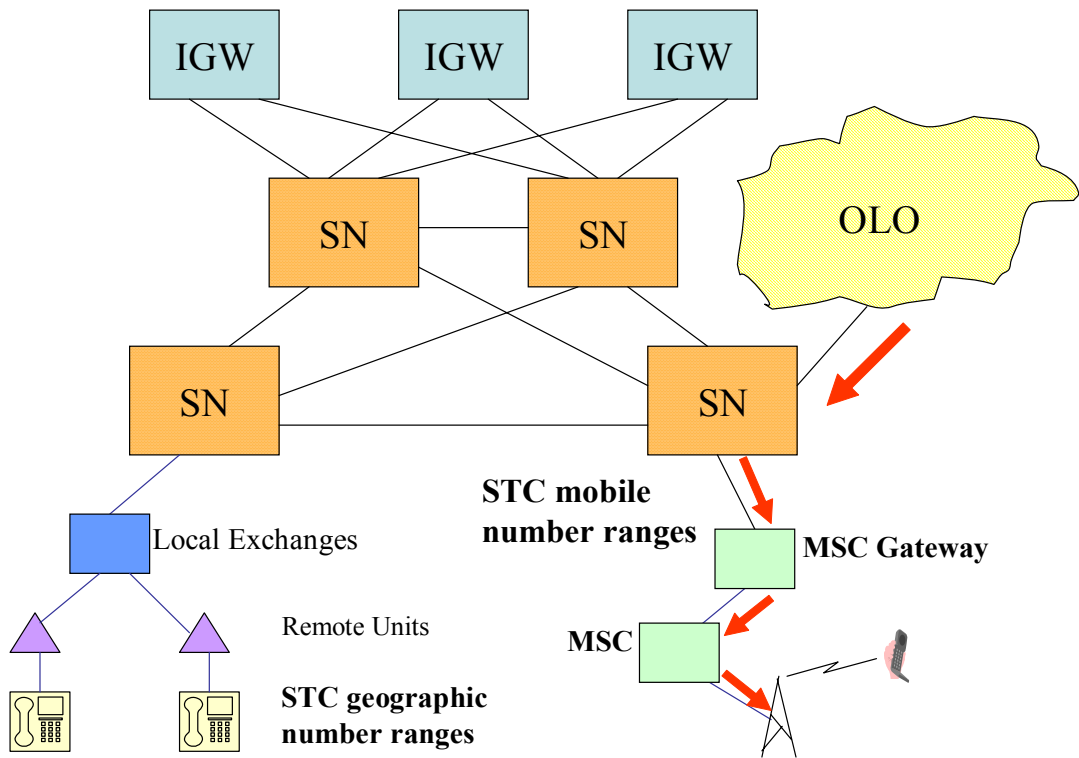

Figure 5.a: Voice Call Terminating on STC Mobile Number Ranges via SN

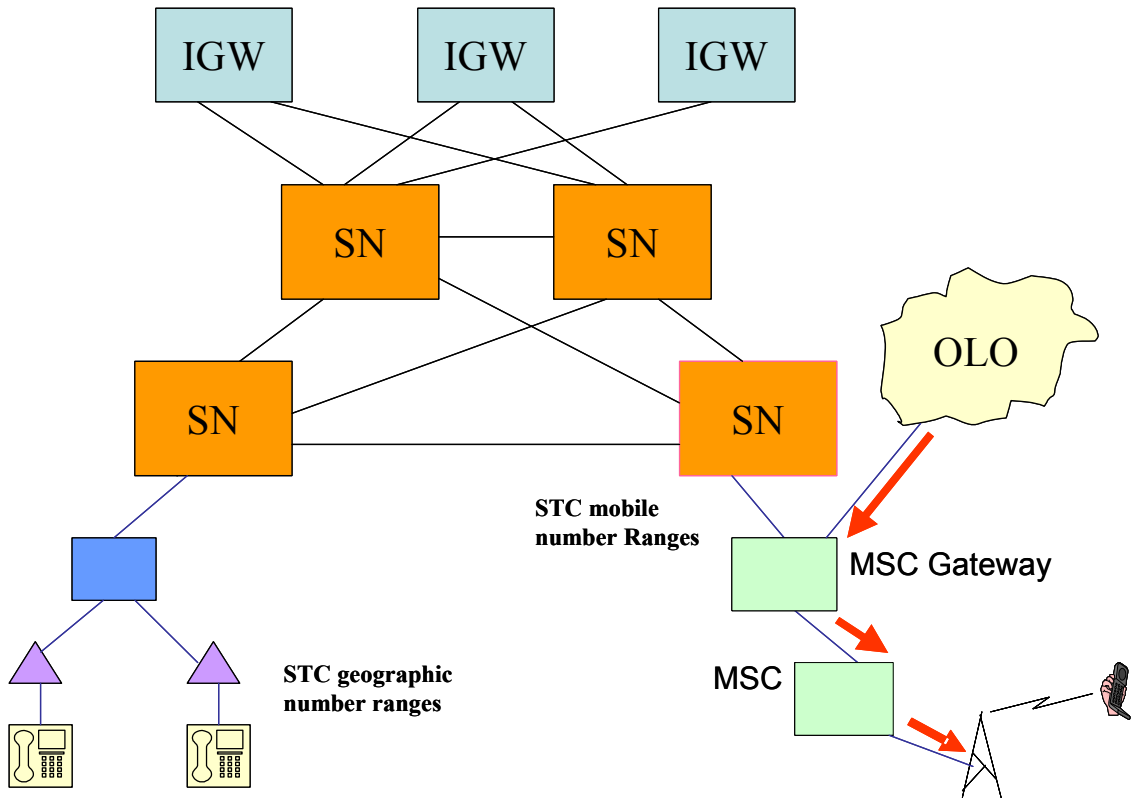

Figure 5 .b: Voice Call Terminating on STC Mobile Number Ranges with direct connection to GMSC

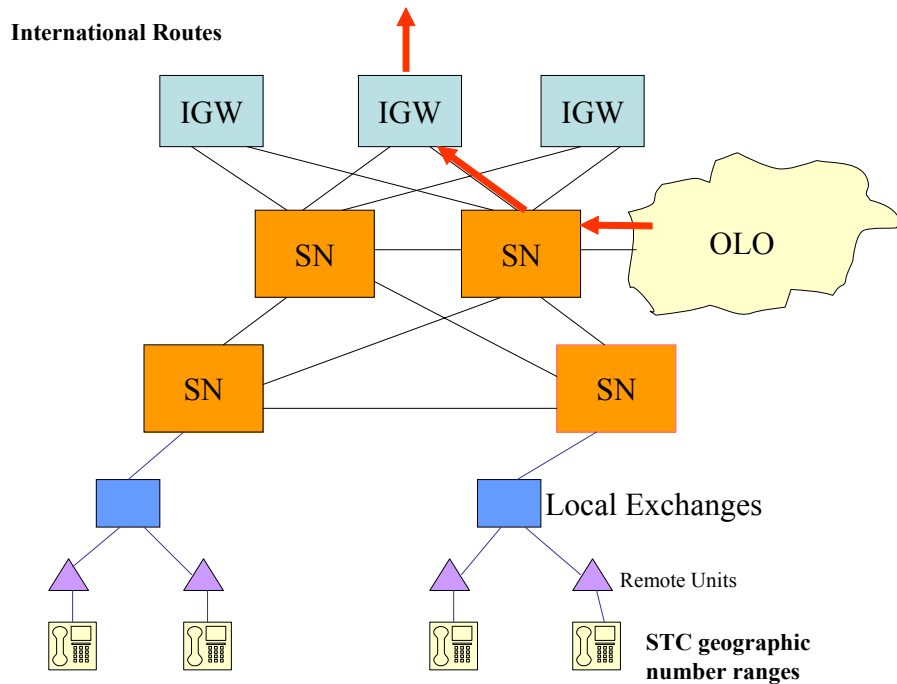
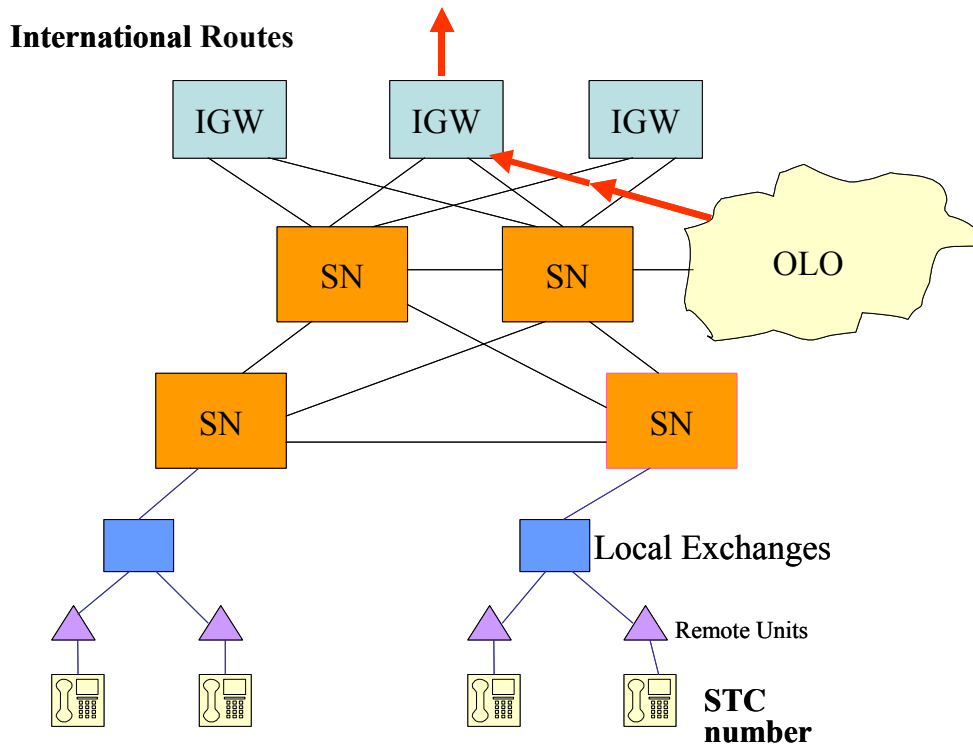

Figure 6.a: Other Licensed Operator Voice Calls Offered for International Conveyance



6 FIGURE 6.B: OTHER LICENSED OPERATOR VOICE CALLS OFFERED FOR INTERNATIONAL CONVEYANCE TRANSPORT NETWORK TOPOLOGY

- 6.1 The STC long distance and junction networks are primarily optical fibre rings, operating at the STM-64, STM-16 STM-4 and STM-1 rate (10 / 2.5 / 0.622 / 0.155 Gb/s). Some heavily utilised routes are equipped with dense wavelength division multiplexing (DWDM). The SDH transport network is part of the core PSTN network, but it also serves all the other STC networks, namely: Data and Mobile.
- 6.2 The rings are configured as self-healing rings and provide connectivity between STC SNs, MSCs, and IGWs. There are also additional rings in the major cities and further access fibre rings connecting some major buildings and customers. This topology is illustrated in Figure 7.

6.3 This STC transmission infrastructure will also be utilized for the provision of wholesale transmission link services.

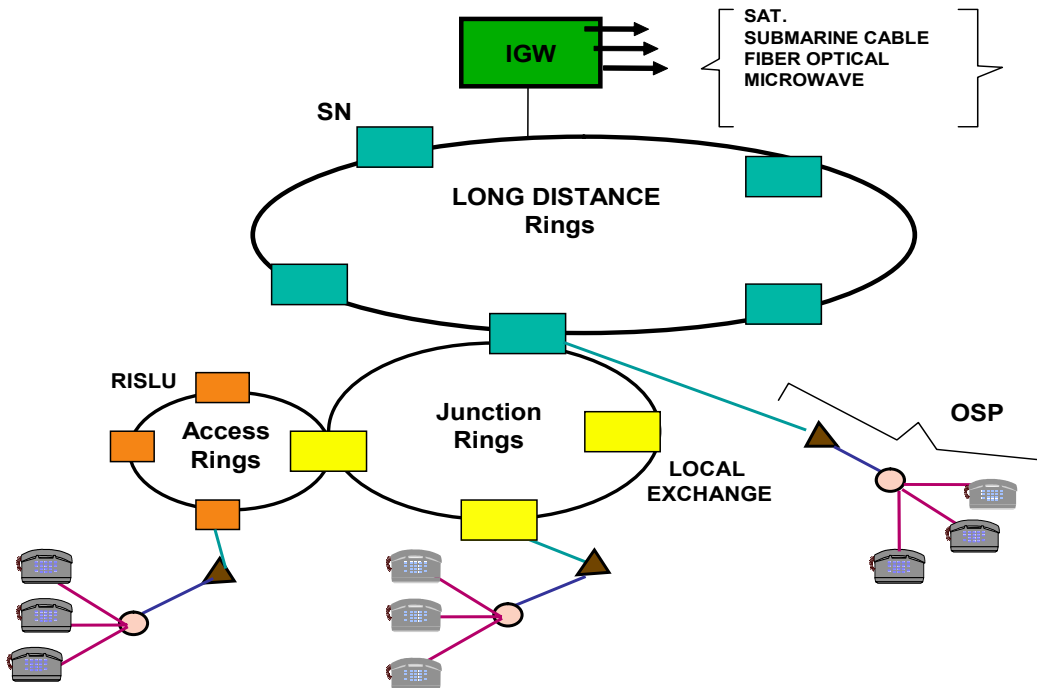

Figure 7: General Architecture of the Transport of the Fixed Telephone Network

7 SIGNALLING NETWORK

7.1 The STC network utilises Signalling System No.7 (SS7) in accordance with ITU-T 7xx series standards with options as adapted to the Kingdom of Saudi Arabia, as described in Attachment 3 (*Saudi Arabia SS7 Signalling Standard*) of this Annex, which provides the standard specifications for Layers 1, 2 and 3 of the Message Transfer Part (MTP). This Attachment 3 also provides the standard specifications for the ISDN User Part (SA-ISUP). The Signalling Point Codes (SPCs) for the POI Service Nodes are provided in Attachment 2 (*Points of Interconnection & Signalling Point Codes*) of this Annex.

- 7.2 The utilisation of SS7 links shall be maintained within the guidelines of ITU-T Q.706 Recommendations of 0.2 Erlang under normal load and 0.4 Erlang under high load (e.g. change over of a parallel link). Higher loads may be permitted as appropriate in the future (e.g. 0.3/0.6 normal/high).
- 7.3 As a part of the Network Plan, referred to in Annex-H (*Operations and Maintenance Manual*), a set of SS7 signalling tests will be performed in order to insure the compatibility and interoperability between STC and the OLO networks at the 3 MTP levels as well as ISUP & Supplementary Services levels. These tests are extracted from the ITU-T Q.780, Q.781, Q.782, Q.784 and Q.785 Recommendations.
- 7.4 Figure 8 below shows an architectural schematic diagram of the STC signalling network, which supports the STC network. In addition, the necessary connections of the OLO Signal Transfer Points (OLO STPs) and International Gateways (IGWs) to the STC National STPs (NSTPs) are shown. The SPCs for the NSTP's are (1000, 1001, 2000, 2001).

Figure 8: Signalling Interconnection

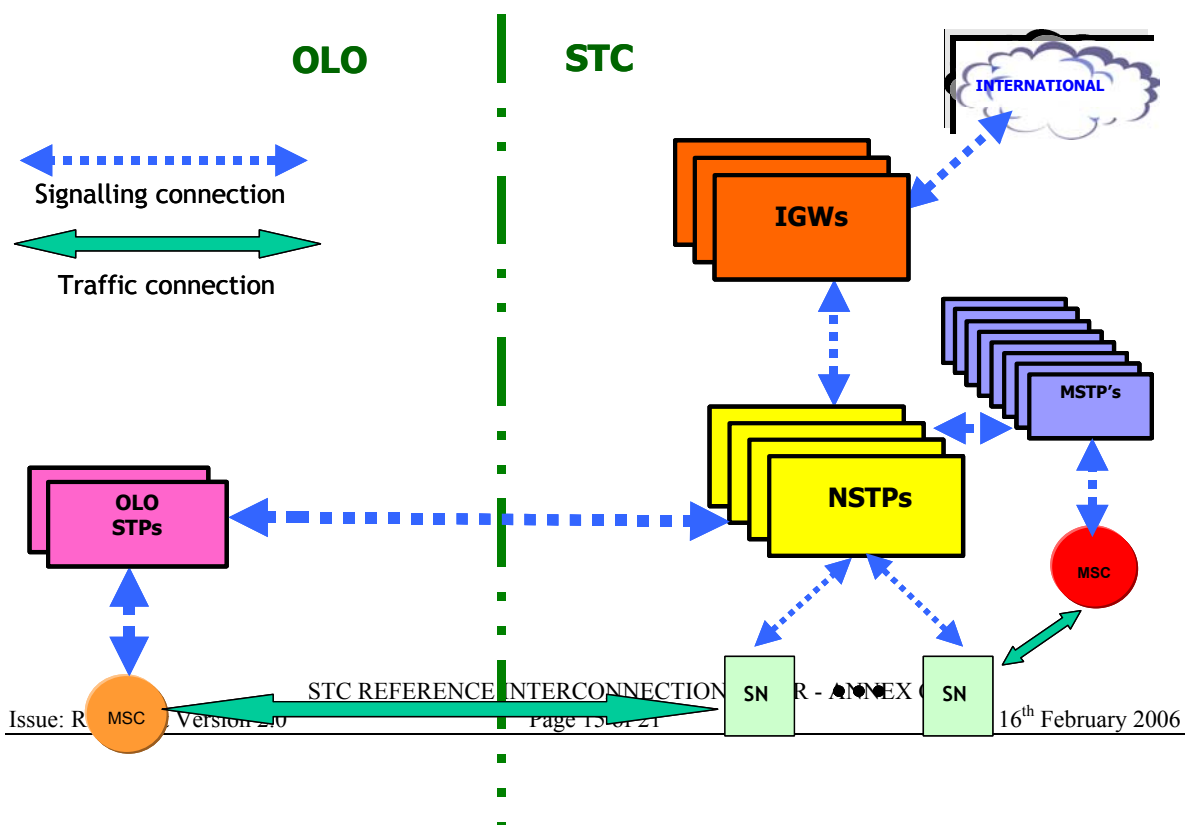

8 SYNCHRONISATION

- 8.1 The STC network synchronisation is generally in line with relevant ITU-T recommendations. In order to establish interconnection, the Other Licensed Operator will fulfil the timing performance requirements of ITU-T recommendation G.811. This can be achieved for Plesiochronous Mode by deriving reference timing from OLO's own Stratum-1 clock or the OLO will receive the Master timing signal from STC.
- 8.2 The specification of the timing system that is required in order to ensure proper operation of the interconnected networks is given in Attachment 5 (*STC Synchronisation Scheme*).
- 8.3 Licensed operators are responsible for the management of synchronisation on their respective networks.

9 INTERFACE STANDARDS

9.1 Electrical E1 Interfaces

- 9.1.1 STC will only consider interconnection with equipment approved by CITC.
- 9.1.2 The Interconnection Link will be a 2 Mbit/s (E1) path having Electrical Interfaces as specified by ITU-T G.703, as follows:

- Bit rate (synchronous) 2048 kbit/s \pm 4.6 ppm
- Nominal value of pulse amplitude
 - Symmetrical connectors 3 V \pm 10 %
 - Coaxial connectors 2.37 V \pm 10 %
- Attenuation 6 dB at 1024 kHz
- Impedance (adjustable with a jumper on the module)
 - Symmetrical connectors 120 Ω
 - Coaxial connectors 75 Ω
- G. 704 Framing structures
- G. 823 Jitter requirements

9.2 Electrical STM-1 Interfaces

9.2.1 For wholesale transmission link services the Other Licensed Operator may elect to purchase higher bandwidth capacity from STC. STC will provide wholesale connectivity with the Other Licensed Operator.

9.2.2 This electrical STM-1 interface will be applicable for such wholesale purposes. This is specified by ITU-T G.703:

- Bit rate 155,520 kbit/s \pm 20 ppm
- Nominal value of pulse amplitude 1 V
- Attenuation 12 dB at 77,760 kHz
- Impedance (coaxial connectors) 75 Ohms
- Reflection attenuation (8 MHz to 240 MHz) 15 dB

9.3 Optical STM-1 Interfaces

9.3.1 The optical STM-1 interface will be as specified by ITU-T G.957

(i) 155 Mbit/s STM-1 Interface (Application Class S-1.1 for Short Hauls)

- Bit rate 155,520 kbit/s \pm 20 ppm
- Code binary (NRZ)
- Wavelength range 1261 nm to 1360 nm
- Attenuation 10 dB to 28 dB

(ii) 155 Mbit/s STM-1 Interface (Application Class L-1.1 for Long Hauls)

- Bit rate 155,520 kbit/s \pm 20 ppm
- Code binary (NRZ)
- Wavelength range 1285 nm to 1330 nm
- Attenuation 10 dB to 28 dB

(ii) 155 Mbit/s STM-1 Interface (Application Class L-1.2 for Long Hauls)

- Bit rate 155,520 kbit/s \pm 20 ppm
- Code binary (NRZ)
- Wavelength range 1480 nm to 1580 nm
- Attenuation 10 dB to 28 dB

10 NUMBERING

10.1 Number Ranges

10.1.1 STC and the Other Licensed Operator will ensure that sufficient and correct numbering information is sent from one Network to the other for correct delivery of calls. The Parties will convey to each other telephone numbers in the national and international formats as contained in the National Numbering Plan issued by CITC.

10.1.2 STC exchanges are designated by their site number, together with the associated NXX number ranges. Attachment 5 provides a list with NXX's associated with all exchanges in the STC network.

10.2 Calling Line Identification Presentation (CLIP).

10.2.1 STC and the Other Licensed Operator will pass the CLI for all calls for which Call Origination and Call Termination Services are provided, including the traffic case which is forwarded from another Network.

10.2.2 For calls handed over from an authorized overseas system, STC will convey, to the extent received, the calling subscriber number associated with those calls.

10.2.3 The parties will resolve any service issues arising from the provision of CLIP from the other party's network, where the CLI is not an actual directory number. A list of all such non-subscriber CLIs ("Dummy CLIs") will be notified by each party to the other party in writing for those Dummy CLIs already in use. The list will be updated from time to time to include those planned for use and those no longer in use. Twenty-eight [28] days' advance notice of the commencement date will be given for Dummy CLIs planned for use.

10.2.4 For calls for which CLIP is not available, such as calls from customer service operator positions, the category of the calling customer will be clearly indicated in the signalling message.

10.2.5 The Parties will comply with the following requirements and safeguards:

- Each Party will not manipulate the CLI of the original calling customer and the original calling customer CLI will accordingly be passed on in the conveyance of a call;
- Each Party will not, in the handling of outgoing traffic, manipulate the access code dialled by the calling customer;
- Each Party will set the A-bit of the Forward Call Indicator (FCI) of the Initial Address Message (IAM) of ISDN User Part (ISUP) to the value “1” to identify an international incoming call.

11 ENVIRONMENTAL AND POWER REQUIREMENTS FOR COLLOCATION

11.1 Environmental Requirements

11.1.1 All equipment provided by the Other Licensed Operator within collocated facilities supplied by STC will comply with the environmental requirements given in Attachment 6 (*Environmental & Power Requirements for Collocation*) of this Annex.

11.1.2 All electrical equipment will comply with EN60950 or IEC 950 and will be supported by a valid certificate of compliance issued by a recognised organisation.

11.2 Power Requirements

11.2.1 48 V DC Sources:

- a) The equipment will operate from a no-break 48V battery supply, with the positive pole earthed. The earth bus will be directly connected to the battery pole.
- b) The guaranteed performance of the equipment will be maintained for variations of the supply as defined in ETS 300 132-2.
- c) The equipment will make provision for reverse polarity protection.

11.2.2 110 or 220 V AC Sources

- a) The guaranteed performance of the equipment will be maintained for variations of the supply as defined in ETS 300 132-1.
- b) The Other Licensed Operator will state the power consumption of the equipment in the idle (no-traffic) state. The maximum power consumption will also be stated.
- c) The Other Licensed Operator will state the ability of the proposed equipment to operate from power supply sources other than the ones stated above. Where optional converters or inverters are offered to cover other primary power supply sources, the additional power consumption that is attributed to these devices will also be stated.

11.2.3 Power System Earthing of the OLO shall be earthed in accordance with TSP 2547 Issue 1 and all the references mentioned therein

11.2.4 Safety

- a) The power system shall be designed and manufactured in a manner that presents the minimum possible safety hazards to operation and maintenance personnel.
- b) All conductors shall be adequately insulated to minimize the risk of inadvertent contact by personnel.
- c) All equipment using AC voltages shall be clearly marked to indicate the various voltage levels.
- d) All distribution fuses, Main Circuit Boards (MCBs) and protection devices shall be clearly marked to indicate the AC or DC voltage levels being present.
- e) The equipment design shall allow maintenance and testing of parts, including the replacement of faulty items, without the risk of contact with dangerous high voltages.
- f) Cables shall be adequately shielded and protected to minimise mechanical damage to the conductors or the insulation.

- g) All exposed metal parts, cabinets, cable trays, cable ladders etc. shall be bonded to the building earth for the protection of the operation and maintenance personnel.
- h) All DC power cables and bus-bars shall be identified at the point of termination by color coding or polarity marking/identification:
- Positive conductor Red.
 - Negative conductor Blue.
- i) All cabling for multiple AC and/or DC system voltages shall be clearly segregated and terminated. System voltages shall be clearly labelled in English and Arabic.
- j) UPS systems employing a high voltage battery greater than 200 V DC, shall be securely constructed to prevent accidental contact with the battery.